

Step 1
Cut out parts

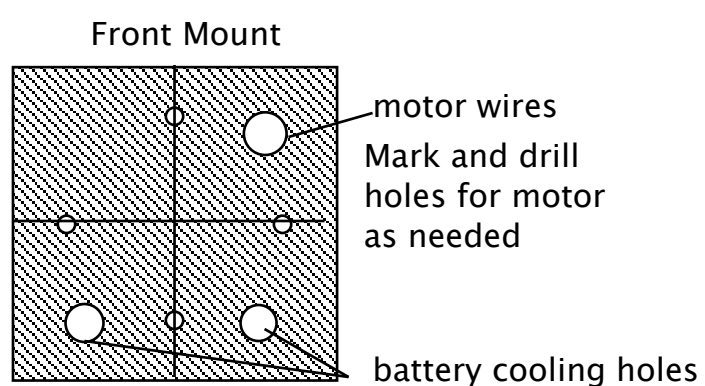

Step 2 bend and glue up sides
install shelf and glue on ply

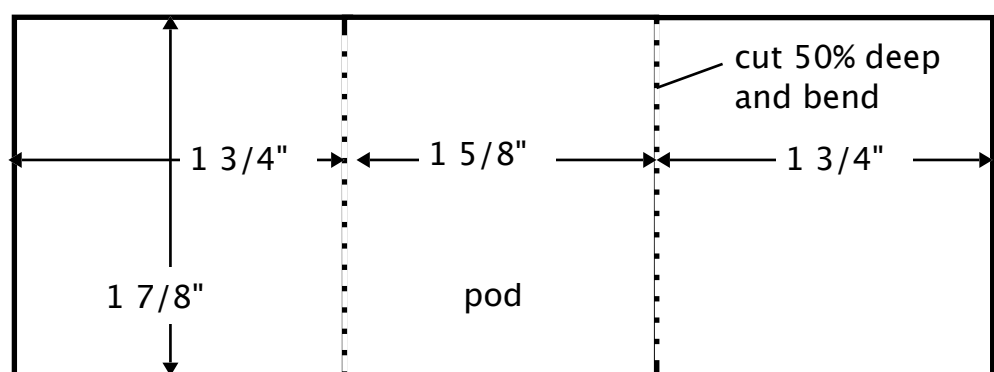
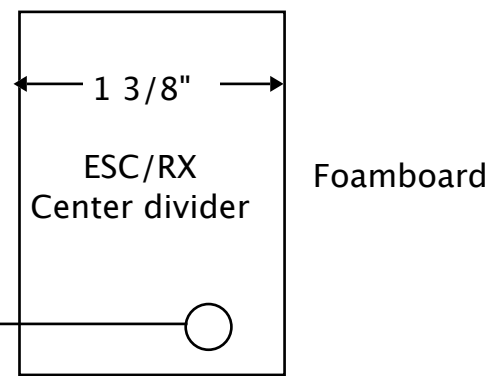
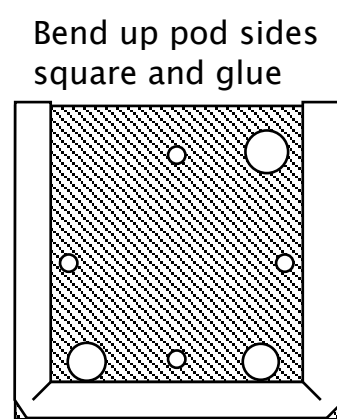

Step 3 Drill all holes
and install components

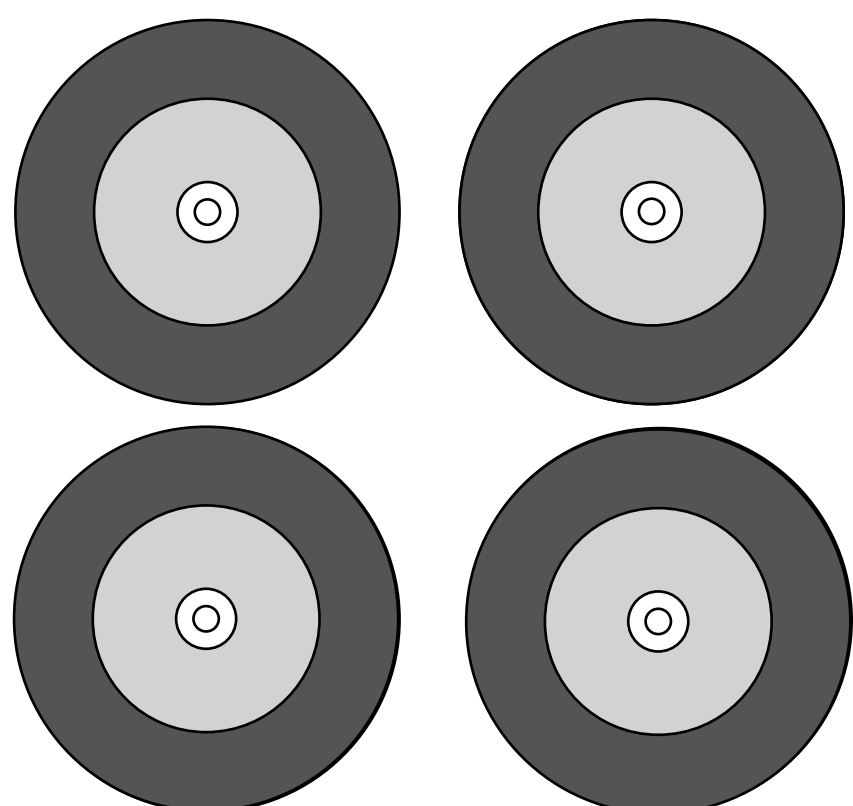
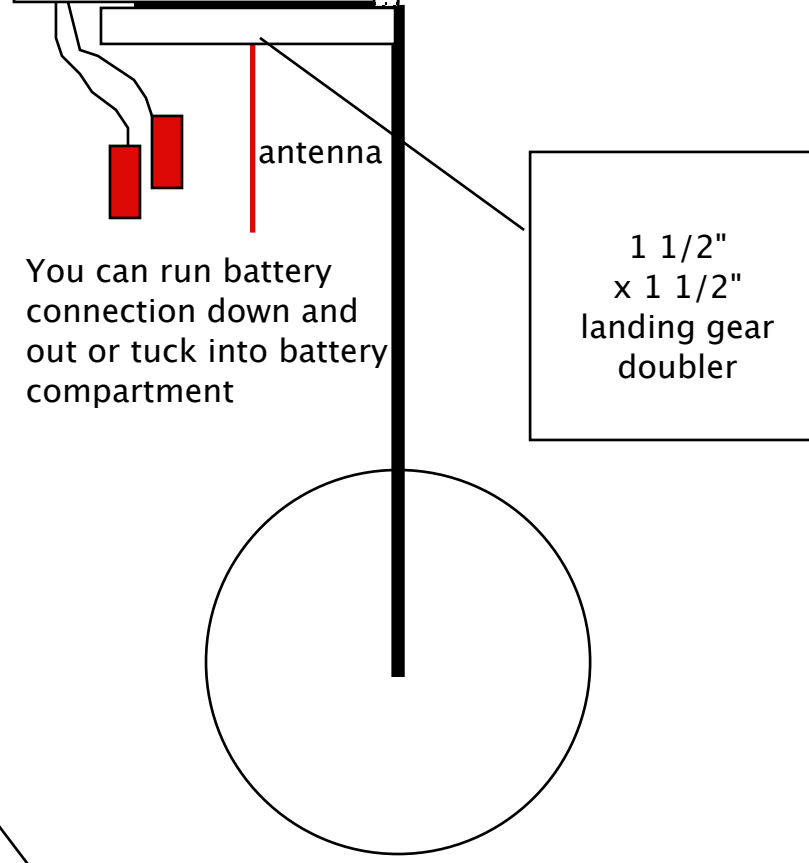
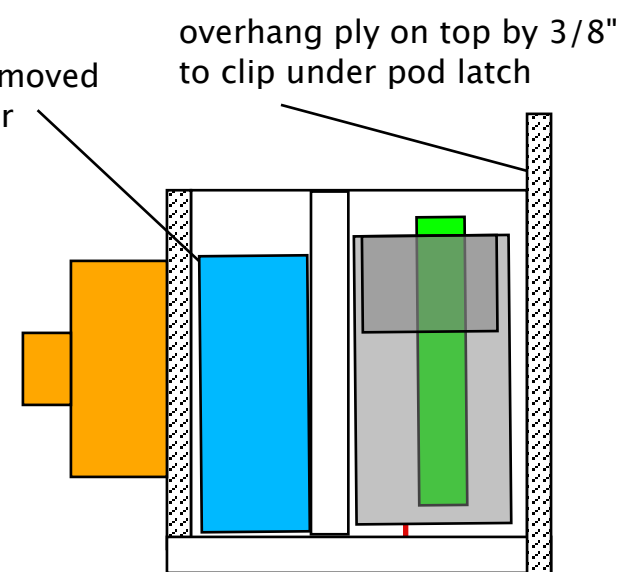
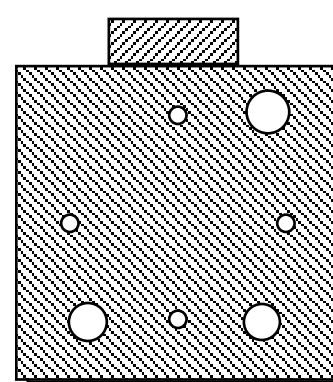

Glue wheel templates to foam
cut out wheels and glue together on
coffee stirrer axles

